

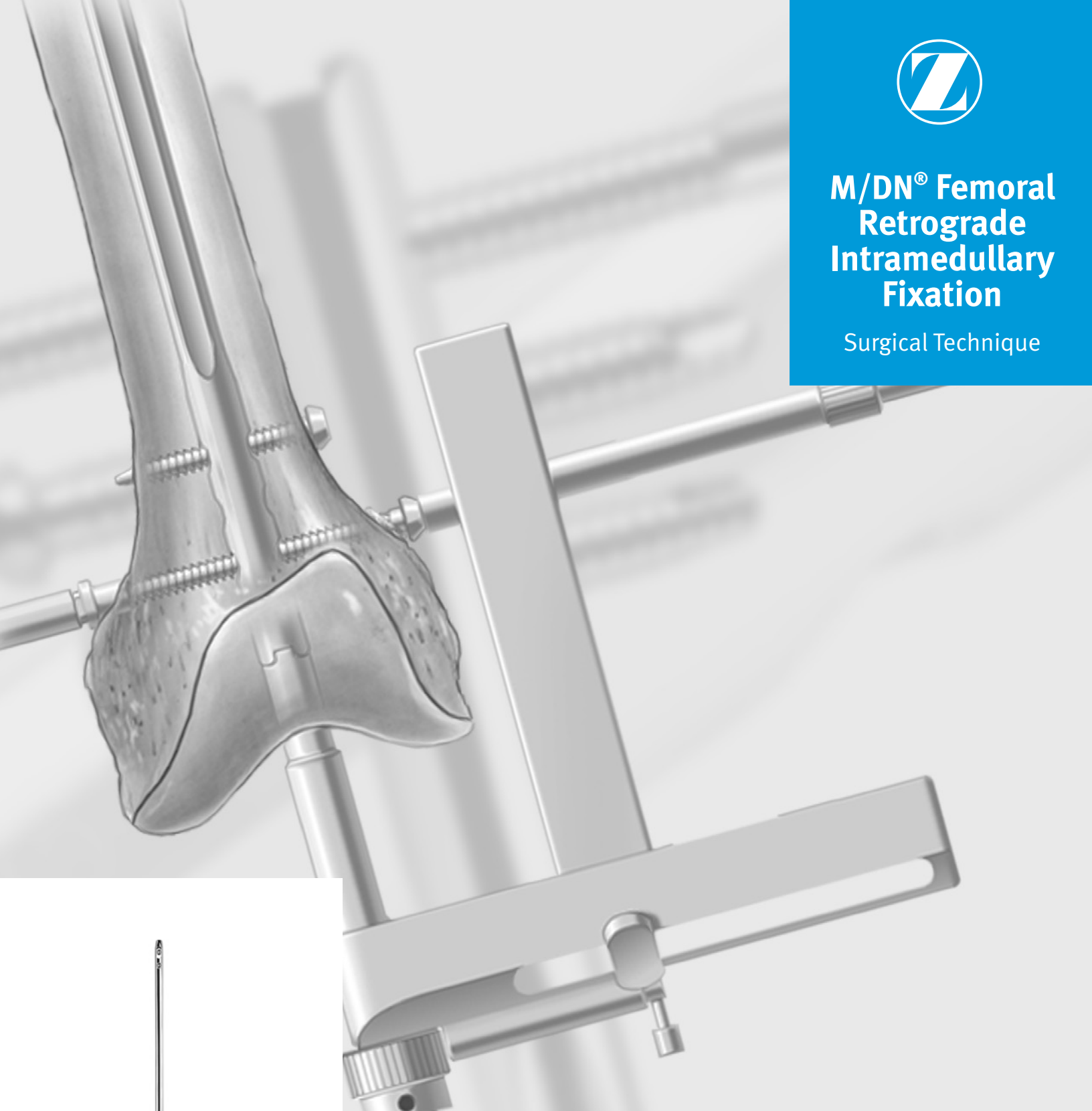

# M/DN<sup>®</sup> Femoral Retrograde Intramedullary Fixation

Surgical Technique





## **Surgical Techniques for Fixation of Fractures with an M/DN Femoral Retrograde Nail**

### **Table of Contents**

|  |    |
|--|----|
| Surgical Technique for the M/DN Femoral Retrograde Nail Fixation | 2  |
| Introduction   | 2  |
| Indications  | 2  |
| Preoperative Planning  | 2  |
| Patient Positioning and Radiographic Control                     | 3  |
| Reduction  | 3  |
| Incision and Exposure  | 3  |
| Creating the Entry Portal  | 4  |
| Guide Wire Placement and Reaming                                 | 5  |
| Nail Insertion   | 7  |
| Distal Locking   | 9  |
| Proximal Locking   | 12 |
| Technique for Using the Free-Hand Targeting Device               | 12 |
| End Cap Placement  | 14 |
| Closure and Postoperative Care                                   | 14 |
| Extraction   | 14 |
| Instrument Case Options  | 15 |

## Surgical Technique for the M/DN Femoral Retrograde Nail Fixation

### Introduction

Retrograde femoral nailing is an alternate technique for the treatment of femoral fractures utilizing an intramedullary nail that is similar to but modified from a standard antegrade femoral nail. The M/DN® Femoral Retrograde Nail is designed for distal fixation and anterior to posterior proximal fixation. The nail is available in six diameters ranging from 9mm to 14mm and lengths from 14cm to 48cm in 2cm increments. The distal end of the retrograde femoral nail is 12mm in diameter for nail sizes 9-12mm.

### Indications

- A. Fractures without Extensive Comminution
- B. Fractures Involving the Femoral Condyles that Require Open Knee Access
- C. Intertrochanteric Femoral Shaft Fractures
- D. Femoral Shaft Fractures with Attendant Femoral Neck Fractures (Nail to be used in conjunction with fixation screws or plates as needed)
- E. Ipsilateral Femorotibial Fractures (“Floating Knee” Fractures)
- F. Distal Fractures Involving Osteoporotic Bone
- G. Closed Supracondylar Fractures
- H. Nonunions or Pseudoarthroses
- I. Malunions
- J. Pathological Fractures
- K. T-condylar Fractures
- L. Severely Comminuted Supracondylar Fractures with Articular Involvement
- M. Femoral Shaft Fractures
- N. Ipsilateral Patellofemoral Fractures

- O. Bilateral Femoral Shaft Fractures

### Preoperative Planning

Proper preoperative planning is essential to successful retrograde nailing of the femur. To determine the appropriate nail size, an ossimeter, roentgenogram templates, and an x-ray film of the unaffected extremity are necessary for determining canal size at the isthmus and for measuring the length of the femur to aid in determining nail length.

The Nail Length Gauge or Harris/Galante Bulb-Tip (Sounds), available in diameters from 10mm to 17mm, can be used as alternate techniques to determine nail diameter and length.

X-rays taken at a 36-inch distance from the x-ray source result in 10-15 percent magnification of bone. The ossimeter has both an actual size scale and one that takes into account this magnification. It should be used routinely to determine nail diameter and length.

The proper length of the nail should extend from 5mm-7mm above the intercondylar notch, proximal to the superior border of the lesser trochanter. The diameter of the femoral nail should match the isthmus in the lateral x-ray projection or the canal reamed to accept the desired nail size.

The surgeon should review the x-ray to assure that there are no unusual anatomic variations.

### Patient Positioning and Radiographic Control

Place the patient in the supine position (Fig. 1) with the knee flexed approximately 30 degrees. Prep the hip to the iliac crest to ensure access to the lesser trochanter.

The use of image intensification is required. The image intensifier should be sterile-draped and may be positioned from either the contralateral or ipsilateral side of the operating table. Positioning from the contralateral side will facilitate insertion of the proximal locking screws. This will also allow the limb to be externally rotated when obtaining a lateral view of the proximal femur for estimating the screw size. Confirm visualization of the hip as well as the shaft of the femur using image intensification before prepping and draping.

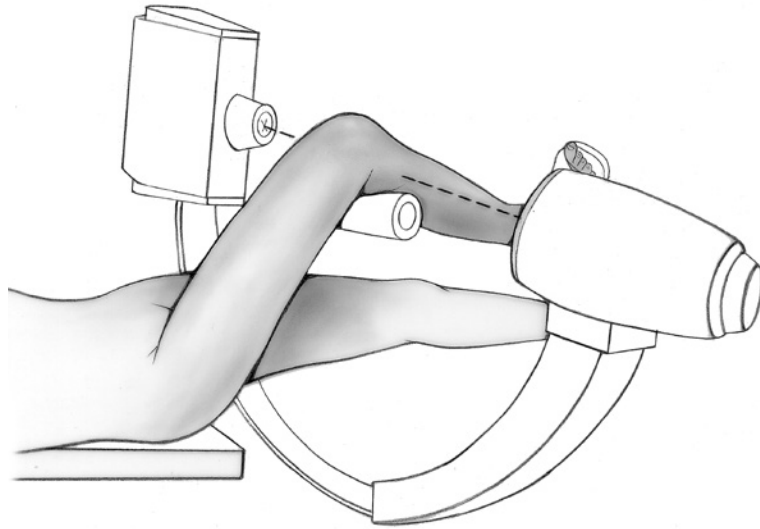

Fig. 1

### Reduction

It is important to reduce the fracture before beginning the surgical procedure.

### Incision and Exposure

Make a medial parapatellar incision in line with the femoral shaft (Fig 2). Dissect the soft tissue medial to the patellar ligament. It is not necessary to expose the femoral condyles as placement of the pin is determined under C-arm control.

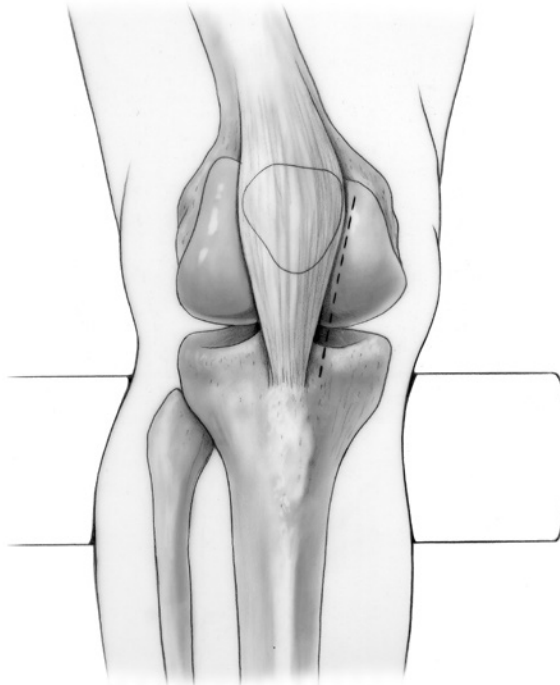

Fig. 2

### Creating the Entry Portal

Locating the entry portal is extremely important to avoid anterior placement of the nail, involvement of the intercondylar notch, mediolateral mal-positioning, or posterior positioning involving the cruciate ligaments.

Place a smooth Steinmann pin through the fat pad and onto the femoral condyles (Fig. 3). Guide the pin to the notch region using gentle pressure to avoid any extraneous scoring of the articular cartilage. Take A/P and lateral views to check the proper position. The starting point should be in line with the femoral canal on the A/P view, and just anterior to where Blumensaat's line intersects the anterior intercondylar notch on the lateral view.

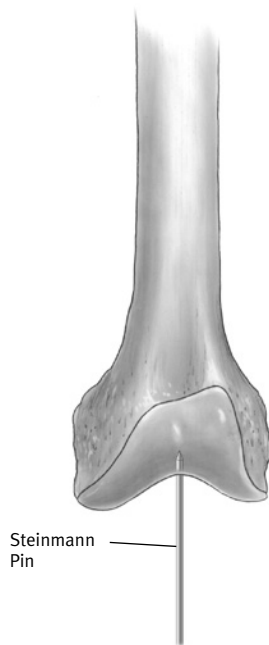

Fig. 3

When the proper position is confirmed, apply firm pressure on the pin so the tip engages and maintains its position. Then adjust the angle of the pin so it is aligned with the femoral canal. Monitor the pin alignment with both A/P and lateral C-arm views as the pin is driven into the bone.

Advance the pin proximally until reduced resistance is felt as the pin exits the metaphyseal region. Make a final check with A/P and lateral views.



Insert the 9mm Trochanteric Reamer over the pin, and ream through the metaphyseal region (Fig. 4). Be sure to follow the path of the pin, allowing the reamer to advance through the metaphyseal bone without binding on the pin and pushing it up the femoral canal. Do not ream into the diaphyseal area. Stop reaming when reduced resistance is felt. Remove the reamer and Steinmann Pin.



Fig. 4

## Guide Wire Placement and Reaming

### Conventional Guide Wire/ Exchange Tube Technique

Attach the 3.0mm Ball-Tip Guide Wire to the Wire-Grip T-Handle and tighten (Fig. 5). The Ball-Tip Guide Wire may also be described as a Bulb-Tip or Bullet-Tip Guide Wire. To aid in manipulation, bend the wire at a 10° angle 5cm from the tip. Insert the Guide Wire through the entry hole and manipulate it up the distal femur. At the fracture site, manipulate the Guide Wire under C-arm control (Fig. 6). Once in the proximal canal, pass the wire to its final position (Fig. 7).

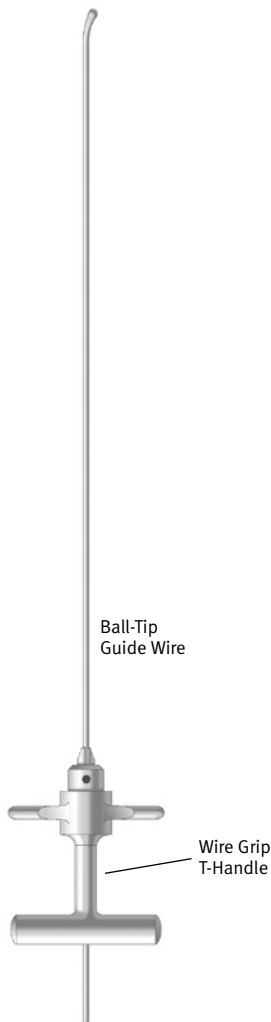

Fig. 5

**CAUTION: If the guide wire is bent shorter than 5cm from the end of the wire and/or more than 10 degrees it may be difficult to remove from the nail. If the wire becomes lodged inside the nail, utilize the WIRE GRIP T-HANDLE and mallet to remove the guide wire from the nail.**

The Reduction Finger can be used to assist in fracture reduction. To use the Reduction Finger, advance the Guide Wire and ream the distal segment. Pass the Reduction Finger over the Ball-Tip Guide Wire. Manipulate the fracture externally while using the Reduction Finger internally to aid in fracture reduction. Once the Ball-Tip Guide Wire has passed through the fracture site, the Ball-Tip Guide Wire is advanced to epiphyseal scar.

If the Ball-Tip Guide Wire can not advance through the fracture site, the ball tip of the Guide Wire should be bent slightly and then reinserted to aid in internal reduction.



Fig. 6

Determine the proper nail length by placing a second Guide Wire of equal length at the intercondylar notch. The length of the wire that is not overlapping is the correct nail length. The 50cm Ruler or ossimeter may be used for an accurate measurement.



Fig. 7

Alternatively, the Nail Length Gauge can be used to measure the appropriate Nail length through measurement of one 100cm guide wire. To use, place a 100cm Guide Wire down the medullary canal. Slide the Nail Length Gauge over the Guide Wire, ensuring that the distal portion of the gauge is resting on the distal femur in order to determine correct nail length. Nail length is determined by noting the location of the remaining Guide Wire and reading the Nail Length Gauge at that particular location. If the length indicated is between two available nail sizes, it is recommended that the shorter nail be chosen.

**NOTE: Nail Length Gauge can only be used with 100cm Guide Wire.**

Remove the Wire-Grip T-Handle, and place an intramedullary reamer over the Guide Wire. The *Pressure Sentinel*® Intramedullary Reaming System is a system of one-piece reamers ranging in size from 5mm diameter to 27mm diameter in half millimeter increments. Each reamer is composed of a fluted reamer head, a shaft and a quick-connect drive end. The quick-connect end can be connected to a manual or powered driver. The width of the isthmus of the medullary canal is determined by preoperative x-ray examination. The instrument with the smallest possible diameter is used for initial reaming into the medullary canal. Reamers with a diameter of 5mm to 7.5mm use a 2.4mm Ball-Tip Guide Wire while reamers with a diameter of 8mm to 27mm use a 3.0mm Ball-Tip Guide Wire. As reaming continues, the reamer size should be increased by 0.5mm or 1.0mm increments until an opening of the desired size is obtained.

**Note: To avoid reamer lodging during use, reaming should be immediately stopped and the reamers retracted when there is too much resistance. If the reamer becomes lodged, stop reaming immediately.**

**Reverse the direction of rotation of the handpiece and back the reamer out of the canal. The reamer can also be extracted by snapping the T-Handle Extractor onto the reamer end and then gently tapping the Extractor with a small mallet or hammer.**

**CAUTION: Excessive blows to the T-Handle Extractor may damage the reamer or the Extractor.**

**NOTE: The distal end of the nail is larger than the shaft diameter on some sizes. Over ream as appropriate to create clearance for the nail. 9mm-11mm nails have a 12mm distal end.**

### New Guide Wire Technique Option

If using a Ball-Tip Guide Wire that does NOT have a gold-coated end OR if using a nail less than 10mm:

**NOTE: If the Guide Wire becomes lodged within the reamer, use the Wire-Grip T-Handle to push the Guide Wire back into the IM canal.**

When the reaming is complete and the final measurements are made, insert the plastic Exchange Tube over the Ball-Tip Guide Wire. Remove the Ball-Tip Guide Wire, and insert a Smooth Guide Wire (Fig 8).

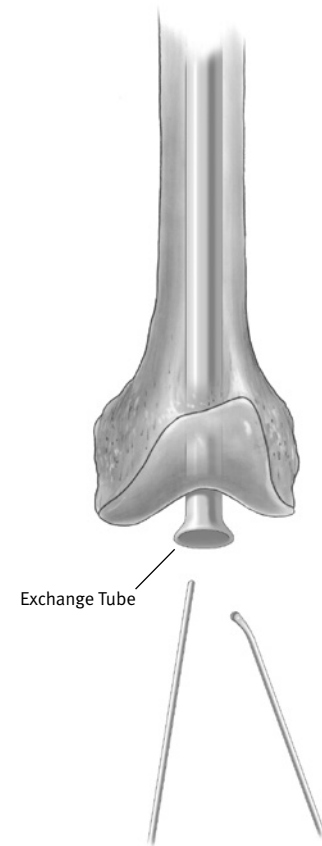

Fig. 8



If using a Ball-Tip Guide Wire that DOES have a gold-coated end and if using a nail equal to or greater than 10mm:

The Ball-Tip Guide Wire can remain in place. It is **NOT NECESSARY** to exchange the Ball-Tip Guide Wire for a Smooth Guide Wire.

### Nail Insertion

Place the selected nail over the Smooth or Ball-Tip (Gold tipped) Guide Wire and into the femur. Slide the adjustable arm of the Retrograde Distal Targeting Guide approximately to the middle of the targeting guide base and tighten the lock knob. Depending on the size of the patient, it may be necessary to adjust the position of the arm in or out.

Attach the Retrograde Distal Targeting Guide to the distal end of the nail (Fig. 9). Be sure the arrow on the guide is pointing to the appropriate “Left” or “Right” indication. Lift and turn the ratchet lever 90 degrees to open the ratchet mechanism of the targeting guide. Insert the Locking Bolt through

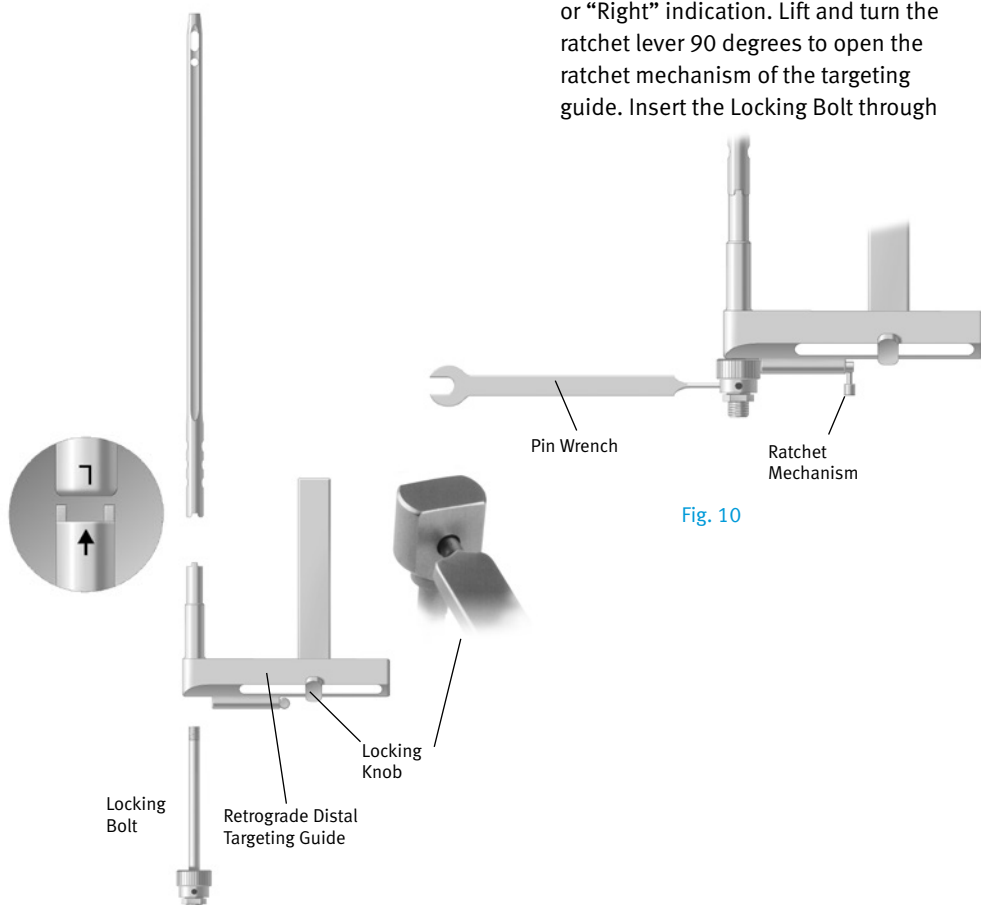

Fig. 9

the barrel of the guide. Lift and turn the ratchet lever 90 degrees to close the ratchet mechanism, and use the Pin Wrench to tighten the Locking Bolt into the distal end of the Nail (Fig. 10).

A keyway in the distal end of the nail will help ensure proper alignment. The ratchet mechanism will prevent the Locking Bolt from loosening during insertion of the nail (Fig. 11).

**NOTE: If the ratchet mechanism of the Retrograde Distal Targeting Guide does not operate freely, it may be necessary to disassemble, clean, and reassemble the mechanism. If the ratchet mechanism becomes inoperative, it may be removed. The assembly will still function; however, the Locking Bolt may loosen during the procedure.**



Fig. 11

Verify proper alignment by inserting the 5.0mm Femoral Drill Bushing into the 8.0mm Femoral Screw Bushing. All retrograde nail sizes use 5.5mm screws distally (Color Code: Green). Place the two guide bushings through one of the inferior holes in the Retrograde Distal Targeting Guide. Insert the 5.0mm Femoral drill through the inner bushing. When the device is properly aligned, the drill will pass through the hole of the nail and will not contact the nail (Fig. 12). After ensuring proper alignment, remove the drill and bushings.

Screw the Threaded Driver or Slaphammer onto the back end of the Locking Bolt. Begin seating the



Fig. 12

nail using gentle impaction. While impacting the nail, use the targeting guide to maintain the proper rotation. Take great care when crossing the fracture site. Visualize the fracture in two planes with image intensification to assure proper passage of the nail into the proximal fragment. Reduce the force of impaction as the distal end of the nail approaches the intercondylar notch.

The Slotted Mallet can be used with the Threaded Driver to make slight upward adjustments in depth (Fig. 13).



Fig. 13

If excessive resistance is encountered during nail driving, remove the nail and check the size of both the reamer and nail. Once proper sizing has been confirmed, the surgeon may choose to over ream the canal further or select a smaller size nail.

Continue to seat the nail. The targeting guide has a shoulder 15mm from the end of the nail (Fig. 14). Using this shoulder as a reference, countersink the nail approximately 5mm-7mm below the intercondylar notch. When the nail is fully seated, remove the Threaded Driver. Then **REMOVE THE GUIDE WIRE.**

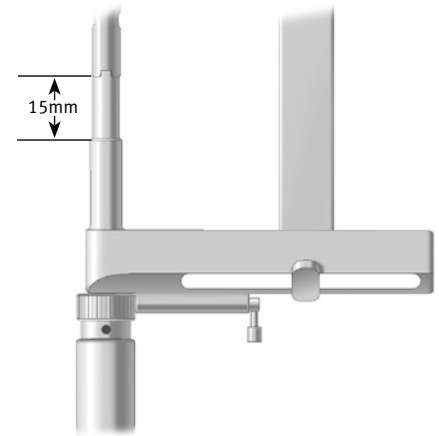

Fig. 14

#### Implant/Instrumentation Specifications for Retrograde Nails

|                               |       |       |       |       |       |       |
|-------------------------------|-------|-------|-------|-------|-------|-------|
| Nail Diameter (mm)            | 9     | 10    | 11    | 12    | 13    | 14    |
| Head Diameter (mm)            | 12    | 12    | 12    | 12    | 13    | 14    |
| Guide Wire, Smooth (mm)       | 3.0   | 3.0   | 3.0   | 3.0   | 3.0   | 3.0   |
| Proximal Screw Size (mm)      | 4.2   | 4.2   | 4.2   | 5.5   | 5.5   | 5.5   |
|                               | blue  | blue  | blue  | green | green | green |
| Proximal Drill Size (mm)      | 3.7   | 3.7   | 3.7   | 5.0   | 5.0   | 5.0   |
| Proximal Trocar Diameter (mm) | 3.7   | 3.7   | 3.7   | 5.0   | 5.0   | 5.0   |
| Distal Screw Size (mm)        | 5.5   | 5.5   | 5.5   | 5.5   | 5.5   | 5.5   |
|                               | green | green | green | green | green | green |
| Distal Drill Size (mm)        | 5.0   | 5.0   | 5.0   | 5.0   | 5.0   | 5.0   |
| Drill Bushing Size (mm)       | 5.0   | 5.0   | 5.0   | 5.0   | 5.0   | 5.0   |

**Note: 4.5mm cortical interlocking screws are NOT indicated for use with the MDN system.**

### Distal Locking

Slide the arm of the Retrograde Distal Targeting Guide toward the knee until it gently contacts the skin, and tighten the Locking Knob with the Pin Wrench. Insert the Femoral Screw Bushing through the Retrograde Distal Targeting Guide. Make a small incision at the point where the bushing contacts the skin. Then insert the 5.0mm Femoral Drill Bushing (Color Code: Green), into the Femoral Screw Bushing. Advance both bushings through the incision until they contact the bone (Fig. 15).

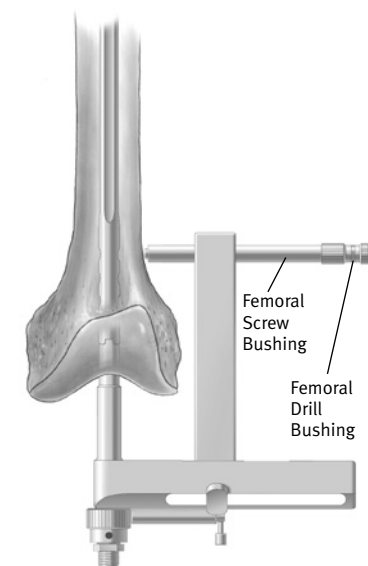

Fig. 15

Insert the 5.0mm Femoral Drill (Color Code: Green) and drill until the medial cortex is penetrated (Fig. 16). Remove the drill and Femoral Drill Bushing.

Use the Long Screw Depth Gauge to determine the screw length (Fig. 17). Select an appropriate length screw to ensure adequate engagement of the outer cortex. Then use the T-Handle Screwdriver to insert the appropriate size screw to the correct has mark (Fig. 18). All retrograde nails use 5.5mm screws distally. Repeat the procedure for the second and third distal screws.

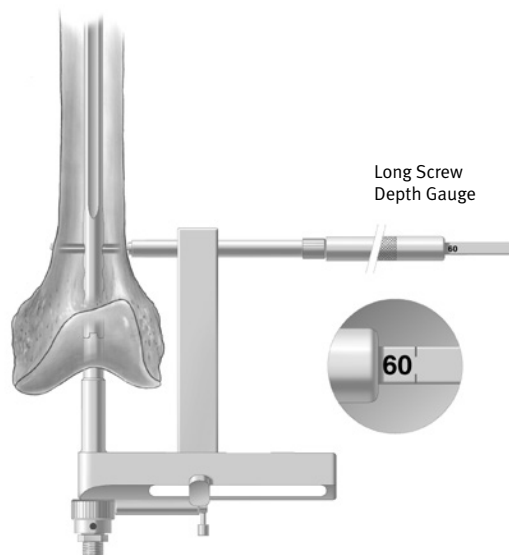

Fig. 17

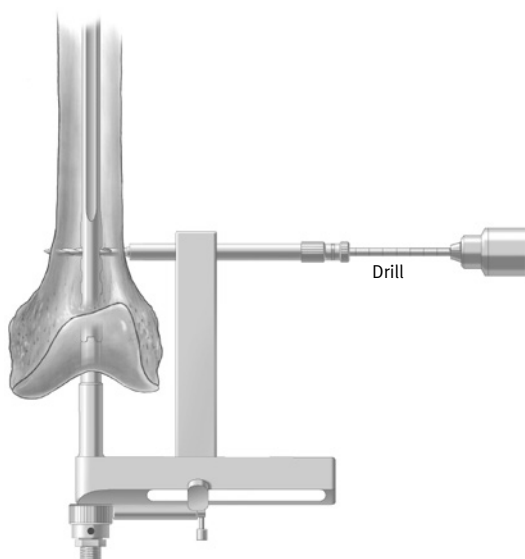

Fig. 16

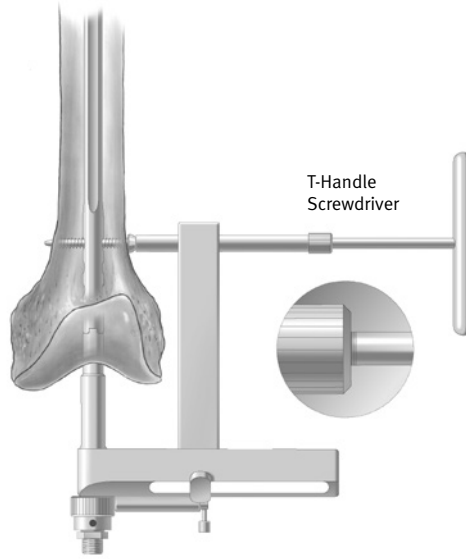

Fig. 18

**NOTE:** Distal locking screws for all femoral nails are 5.5mm in diameter with lengths ranging from 20mm to 100mm in 2.5mm increments. These are inserted from lateral to medial. The proximal anterior to posterior locking screws for the 9mm through 11mm nails are 4.2mm in diameter with lengths ranging from 20mm to 90mm in 2.5mm increments. For the 12mm through 14mm diameter nails, the 5.5mm locking screw can be used at the proximal anterior to posterior locking screw positions (Available in 2.5mm length increments).

**Note:** 4.5mm cortical interlocking screws are NOT indicated for use with the MDN system.

If the bone is osteoporotic, a Cortical Nut and Washer are available to prevent the screw(s) from pulling out of the bone. After inserting the Femoral Screw Bushing, insert the 3.7mm radiolucent R-T Bushing (blue). Then insert a 3.2mm Steinmann Pin into the R-T Bushing. Use the drill to

drive the pin through both cortices (Fig 19). Palpate the pin on the medial side of the knee, and make a small skin incision to expose the tip of the pin.

Insert the Cortical Nut Counterbore over the pin and bore into the medial bone (Fig. 20). Remove the Steinmann Pin, and the Femoral Pin/Drill Bushing. Then use the drill to drill through both cortices (Fig. 21). Remove the Femoral

Drill Bushing and use the Long Screw Depth Gauge to determine the screw length (Fig. 22). **Select an appropriate length screw to ensure adequate engagement of the far cortex.**

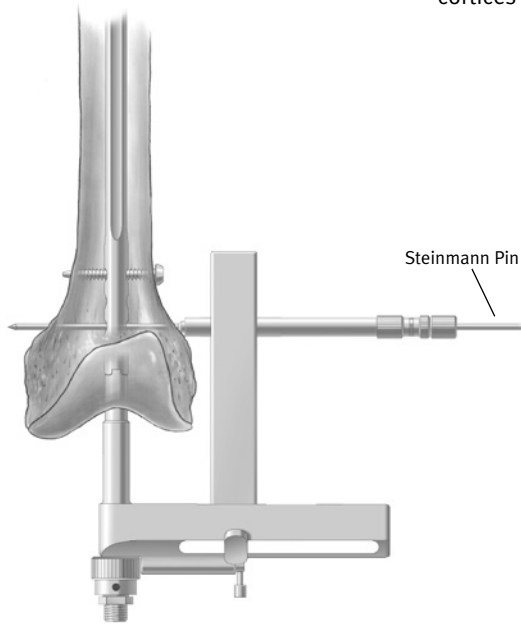

Fig. 19

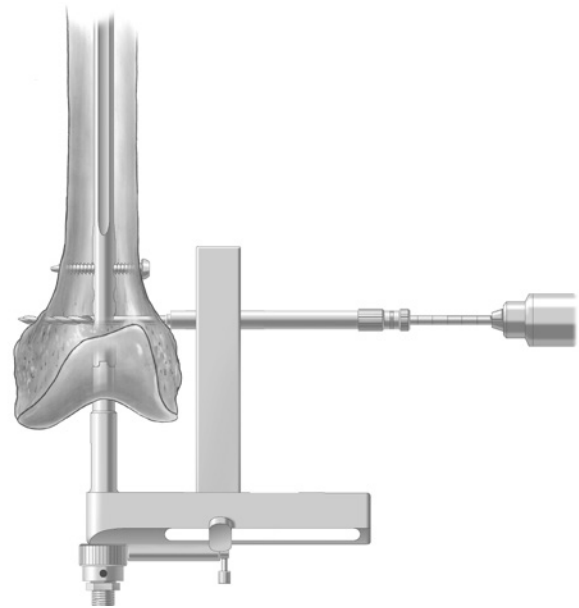

Fig. 21

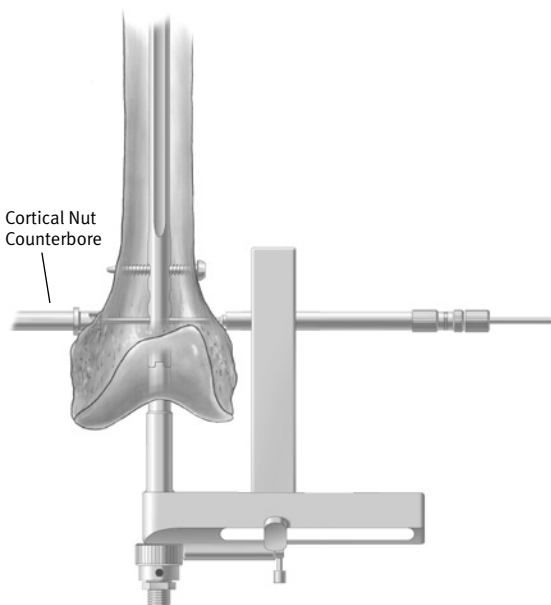

Fig. 20

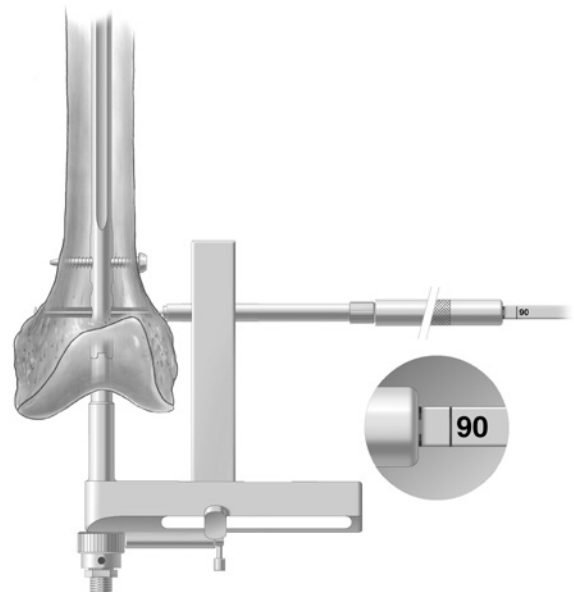

Fig. 22

Use the T-Handle Screwdriver to insert the appropriate size screw through the targeting guide. Before the screw enters the wound, insert a washer onto the screw (Fig. 23). Then begin driving the screw into the bone and through the hole in the nail.

As the screw penetrates the opposite cortex, observe the screw entering the cortical nut (Fig 24). Use an image intensifier to verify proper alignment. Continue to drive the screw until the Cortical Nut is tight. Be careful not to overtighten.

Remove the screwdriver and Femoral Screw Bushing. Take A/P and lateral C-arm views to check for correct positioning. Disengage the ratchet mechanism, then loosen and remove the Locking Bolt and the Retrograde Distal Targeting Guide.

To avoid nonunion and leg length discrepancy, take A/P and lateral C-arm views to be sure that the fracture is at the proper length and not distracted. If there appears to be distraction, lightly tap the nail in until the cortices are properly engaged.

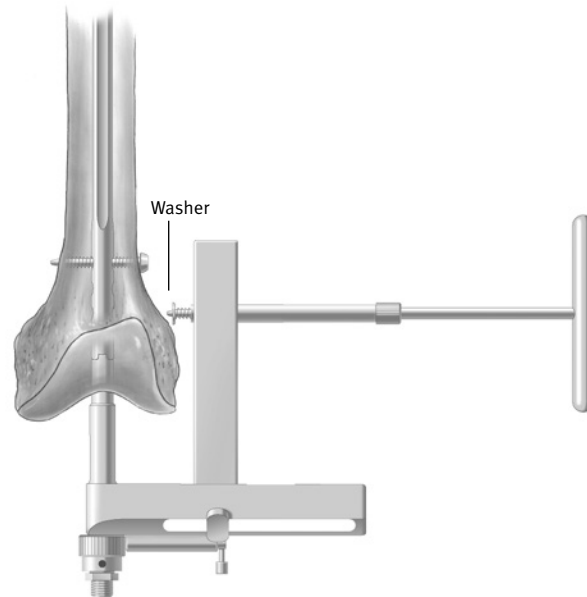

Fig. 23

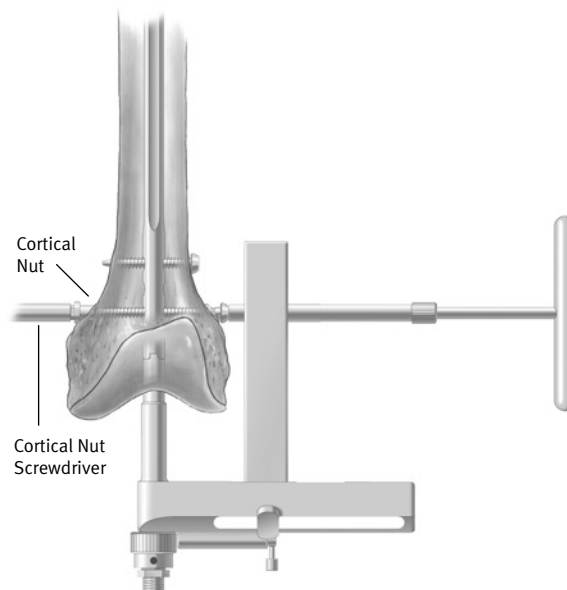

Fig. 24

## Proximal Locking

### Technique for Using the Free-Hand Targeting Device

The proximal locking screws may be inserted with a freehand technique using the Free-Hand Targeting Device.

**NOTE: 9mm-11mm retrograde nails use 4.2mm screws proximally which require 3.7mm Drills or Trocars (Color Code: Blue). 12mm-14mm retrograde nails use 5.5mm screws proximally which require 5.0mm**

**Drills or Trocars (Color Code: Green).**

Insert an appropriate size Trocar into the Free-Hand Targeting Device and finger tighten.

**NOTE: 14cm - 22cm length nails in all diameters have one lateral/medial proximal dynamic slot and one static locking hole. 24cm - 48cm length nails in all diameters have one anterior/posterior dynamic slot and one static locking hole.**



Incorrect



Correct

Fig. 25

Choose the appropriate locking hole based on the need for dynamization. The inferior locking hole on the *M/DN* Retrograde Nail is used for static locking. If static locking is preferred, but there is a potential need for later dynamization, insert screws in both locking holes. The locking screw in the static hole can then be removed to achieve later dynamization.

For success with this technique, proper placement of the A/P x-ray beam is critical. Position the C-arm so the locking hole of the nail appears perfectly round on the monitor or, if using the dynamic slot, the slot should reveal its greatest width (Fig. 25).

When this is achieved, make an anterior stab wound opposite the appropriate locking hole. Bring the tip of the Trocar to the bone and center it over the locking hole using the C-arm (Fig. 26).

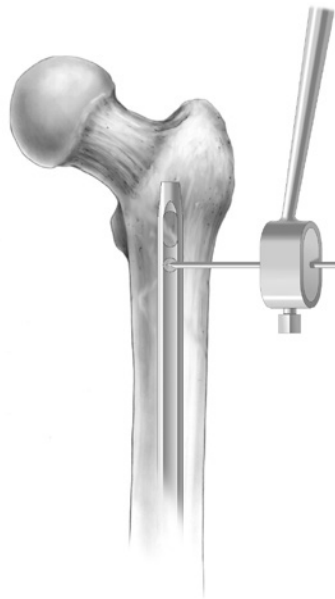

Fig. 26

Drive the Trocar into the bone and across the hole in the nail in line with the A/P x-ray beam, but do not penetrate the posterior cortex (Fig. 27).

Remove the Free-Hand Targeting Device. Verify Trocar placement in both the A/P and lateral planes. Proximal Bushings can be used with the Free-Hand Targeting Device. A separate radiolucent Bushing Insert is available to accommodate the bushings. Insert the 3.7mm or 5.0mm Proximal Bushing and the 8.0mm Proximal Bushing into the targeting device, and place it over the Trocar (see chart on page 6 for correct size information). Advance the bushings to the bone and check their position with the C-arm.

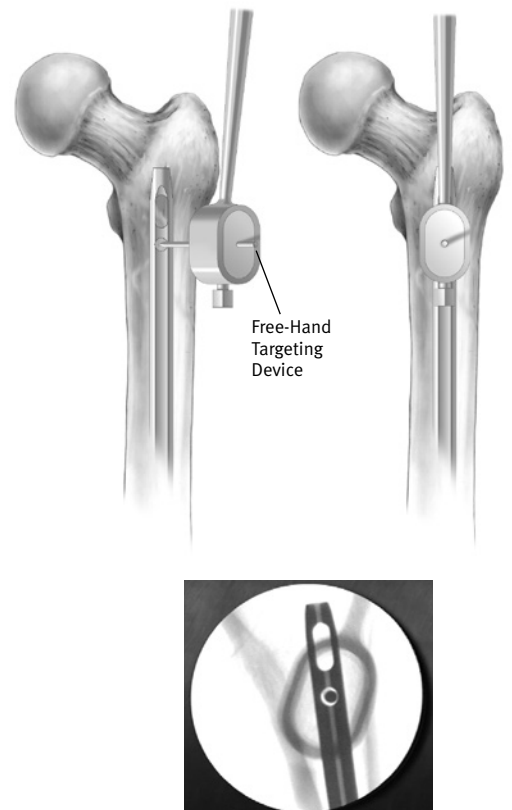
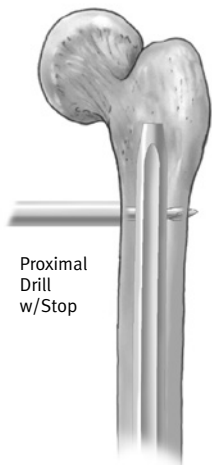

Fig. 27

**Note: 4.5mm cortical interlocking screws are NOT indicated for use with the MDN system.**

After it has been correctly placed, remove the Trocar and the 5.0mm Proximal Bushing. The path of the Trocar in the bone acts as a pilot hole for the appropriate size drill. Insert the Proximal Stop Drill into the 8.0mm Proximal Bushing. Before drilling through the anterior cortex, check the A/P and lateral C-arm image to assure that the drill is in the hole in the nail. Then drill both cortices. The step in the drill will prevent over-drilling (Fig. 28).



Proximal  
Drill  
w/Stop

Fig. 28

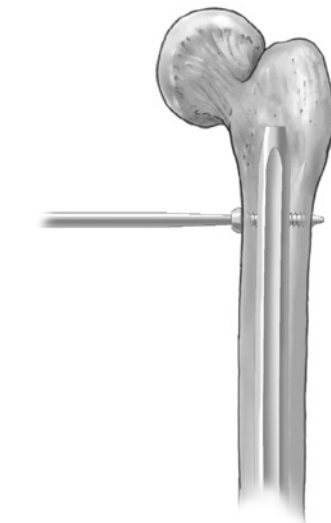
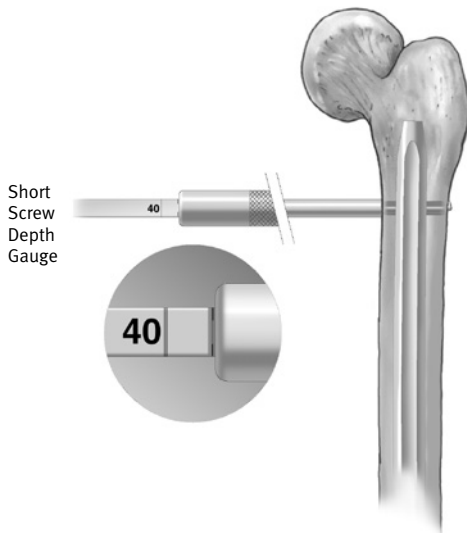

Fig. 30



Short  
Screw  
Depth  
Gauge

40

Fig. 29



Fig. 31

If desired, insert the second screw in the second locking hole of the nail in an identical manner (Fig. 31). Check the position of both screws with the C-arm in the A/P and lateral planes (Fig. 32).

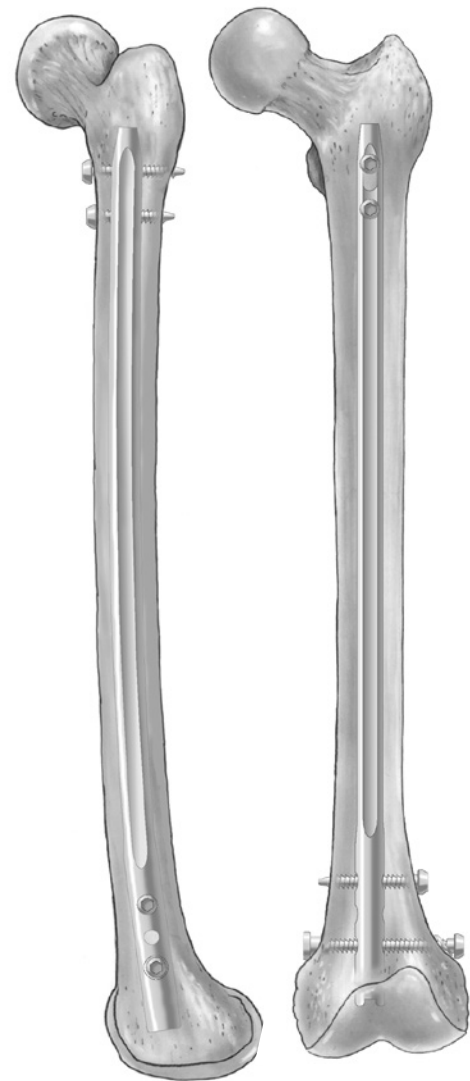

Fig. 32

### End Cap Placement

If desired, insert the Retrograde Femoral Locking Nail Cap in the distal end of the nail to ensure secure fixation with the distal oblique screw.

### Closure and Postoperative Care

Thoroughly irrigate the knee and close the distal wound. Apply a soft compression dressing.

### Extraction

Should extraction of the nail become necessary, attach the Threaded Extractor to the end of the nail and use a Slaphammer to extract the nail. If an End Cap had been used, be sure to remove before attempting to remove the nail.

**NOTE: The cannulated Locking Bolt should not be used for nail removal. Extraction of the nail should be accomplished by using the Threaded Extractor.**



## Instrument Case Options

### M/DN Instruments

#### Option A (Metal Femoral/MIS Femoral/Retrograde)

Set Number 00-2255-000-17 (includes case/tray/lid + instruments)

Case Set Number 00-2237-090-00 (includes trays and lid)

#### Metal Femoral Guides/Instruments (top tray holds the following)

| Prod. No.      | Description                            |   |
|----------------|--|---|
| 00-2255-001-03 | Locking Bolt Assembly                  | 2 |
| 00-2255-002-10 | Fem. Prox. Targeting Guide             | 1 |
| 00-2255-002-11 | Fem. Prox. Targeting Guide             | 1 |
| 00-2255-004-32 | 3.2mm Pin Bushing                      | 2 |
| 00-2255-004-50 | 5.0mm Drill Bushing                    | 2 |
| 00-2255-004-80 | 8.0mm Screw Bushing                    | 2 |
| 00-2255-011-00 | Recon Screw Counterbore                | 1 |
| 00-2258-067-00 | <i>ITST</i> ® Threaded Guide Pin 355mm | 3 |
| 00-2255-028-00 | Pin Wrench                             | 1 |
| 00-2255-035-50 | 5.0mm Femoral Drill, Large             | 3 |

#### MIS Guides (middle tray holds the following; must be used with above tray)

| Prod. No.      | Description                |   |
|----------------|----------------------------|---|
| 00-2255-003-03 | Perc. Recon Arm Set Screw  | 2 |
| 00-2255-028-00 | Pin Wrench                 | 1 |
| 00-2255-050-01 | Fem. Perc. Targeting Guide | 1 |
| 00-2255-050-02 | Fem. Perc. Targeting Guide | 1 |
| 00-2255-051-00 | Perc. Recon Arm            | 1 |
| 00-2255-053-00 | Perc. Cannula              | 1 |
| 00-2255-054-00 | Perc. Centering Bushing    | 1 |
| 00-2255-058-00 | Per. Locking Bolt          | 2 |

#### Retrograde Femoral Instruments (base of case holds the following)

| Prod. No.      | Description                              |   |
|----------------|--|---|
| 00-2241-001-00 | Retro. Targ. Guide Assembly (4 pcs.)     | 1 |
| 00-2241-001-01 | Adj. Targ. Arm Assembly (5 pcs.)         | 1 |
| 00-2241-006-00 | Cortical Nut Screwdriver                 | 1 |
| 00-2241-008-37 | 3.7mm Drill Bushing                      | 2 |
| 00-2241-008-50 | 5.0mm Drill Bushing                      | 2 |
| 00-2258-067-00 | <i>ITST</i> Threaded Guide Pin 355mm     | 3 |
| 00-2255-001-00 | Locking Bolt                             | 2 |
| 00-2255-004-80 | 8.0mm Screw Bushing                      | 2 |
| 00-2255-028-00 | Pin Wrench                               | 1 |
| 00-2255-031-37 | 3.7mm Drill                              | 1 |
| 00-2255-035-50 | 5.0mm Drill, Large                       | 1 |
| 00-2255-059-00 | Nail Cap Inserter (captured screwdriver) | 1 |

**M/DN Instruments****Option B (Metal Femoral/Tibial/Humeral/Retrograde)**

Set Number 00-2255-000-18 (includes case/tray/lid + instruments)

Case Set Number 00-2237-068-00 (includes trays and lid)

**Metal Femoral Guides/Instruments (top tray holds the following)**

| Prod. No.      | Description                          |   |
|----------------|--------------------------------------|---|
| 00-2255-001-03 | Locking Bolt Assembly                | 2 |
| 00-2255-002-10 | Fem. Prox. Targeting Guide           | 1 |
| 00-2255-002-11 | Fem. Prox. Targeting Guide           | 1 |
| 00-2255-004-32 | 3.2mm Pin Bushing                    | 2 |
| 00-2255-004-50 | 5.0mm Drill Bushing                  | 2 |
| 00-2255-004-80 | 8.0mm Screw Bushing                  | 2 |
| 00-2255-011-00 | Recon Screw Counterbore              | 1 |
| 00-2258-067-00 | <i>ITST</i> Threaded Guide Pin 355mm | 3 |
| 00-2255-028-00 | Pin Wrench                           | 1 |
| 00-2255-035-50 | 5.0mm Femoral Drill, Large           | 3 |

**Tibial/Humeral Instruments (middle tray holds the following)**

| Prod. No.      | Description                      |   |
|----------------|----------------------------------|---|
| 00-2255-001-00 | Locking Bolt                     | 2 |
| 00-2255-003-00 | Tibial Proximal Targeting Guide  | 1 |
| 00-2255-003-01 | Tibial Oblique Hole Adapter      | 1 |
| 00-2255-003-03 | Set Screw                        | 2 |
| 00-2255-004-00 | Humeral Proximal Targeting Guide | 1 |
| 00-2255-004-01 | Humeral Oblique Hole Adapter     | 1 |
| 00-2255-036-37 | Tib./Hum. 3.7mm Drill Bushing    | 2 |
| 00-2255-036-80 | Tib./Hum. 8.0mm Screw Bushing    | 2 |
| 00-2255-028-00 | Pin Wrench                       | 1 |
| 00-2255-032-37 | Tib./Hum. 3.7mm Drill            | 2 |

**Retrograde Femoral Instruments (base of case holds the following)**

| Prod. No.      | Description                                 |   |
|----------------|---|---|
| 00-2241-001-00 | Retro. Targ. Guide Assembly (4 pcs.)        | 1 |
| 00-2241-001-01 | Adj. Targ. Arm Assembly (5 pcs.)            | 1 |
| 00-2241-006-00 | Cortical Nut Screwdriver                    | 1 |
| 00-2241-008-37 | 3.7mm Drill Bushing                         | 2 |
| 00-2241-008-50 | 5.0mm Drill Bushing                         | 2 |
| 00-2258-067-00 | <i>ITST</i> Threaded Guide Pin 355mm        | 3 |
| 00-2255-001-00 | Locking Bolt                                | 2 |
| 00-2255-004-80 | 8.0mm Screw Bushing                         | 2 |
| 00-2255-028-00 | Pin Wrench                                  | 1 |
| 00-2255-031-37 | 3.7mm Drill                                 | 1 |
| 00-2255-035-50 | 5.0mm Drill, Large                          | 1 |
| 00-2255-059-00 | Nail Cap Inserter<br>(captured screwdriver) | 1 |

**General Instrument Set**

Set Number 00-2255-000-16 (includes case/tray/lid + instruments)  
Case Set Number 00-2237-095-00 (includes trays and lid)

**General Instruments (top tray holds the following)**

| Prod. No.      | Description                   |   |
|----------------|-------------------------------|---|
| 00-2237-053-00 | Wire Grip T-Handle            | 1 |
| 00-2237-061-00 | Long T-Handle Cannulated Awl  | 1 |
| 00-2237-066-00 | Short T-Handle Cannulated Awl | 1 |
| 00-2255-016-00 | 7mm Angled Femoral Awl*       | 1 |
| 00-2255-034-00 | Reduction Finger              | 1 |
| 00-2255-052-00 | 9mm/14mm Perc. Tapered Reamer | 1 |
| 00-2255-060-00 | 8mm Trochanteric Reamer       | 1 |
| 00-2258-067-00 | ITS Threaded Guide Pin 355mm  | 3 |
| 00-2255-038-00 | T-Handle                      | 1 |
| 00-4816-060-00 | Ball-Spiked Pusher            | 1 |
| 00-4817-011-00 | Shoulder Hook                 | 1 |

**General Instruments (middle tray holds the following)**

| Prod. No.      | Description                 |   |
|----------------|-----------------------------|---|
| 00-2228-097-00 | Diameter Gauge              | 1 |
| 00-2237-055-00 | Ruler                       | 1 |
| 00-2255-057-00 | Flexible Reamer Extension   | 2 |
| 00-2305-024-00 | Screwdriver, Small Hexhead  | 1 |
| 00-2237-060-00 | Slotted Mallet              | 1 |
| 00-2237-062-00 | Threaded Driver             | 1 |
| 00-2237-063-00 | Screw Depth Gauge, Long     | 1 |
| 00-2255-013-00 | Screwdriver 3.5mm Hex, Long | 1 |
| 00-2255-017-00 | Flared Exchange Tube        | 1 |
| 00-2237-064-00 | Nail Length Gauge           | 1 |
| 00-2258-057-00 | Cannulated Depth Gauge      | 1 |

**General Instruments (base of case holds the following)**

| Prod. No.      | Description                  |   |
|----------------|------------------------------|---|
| 00-2255-009-00 | Slaphammer                   | 1 |
| 00-2255-028-00 | Pin Wrench                   | 1 |
| 00-2237-065-00 | Threaded Extractor (17cm)    | 1 |
| 00-2237-065-01 | Threaded Extractor (32cm)    | 1 |
| 00-2255-012-33 | 3.2mm Trocar                 | 3 |
| 00-2255-012-37 | 3.7mm Trocar                 | 3 |
| 00-2255-012-50 | 5.0mm Trocar                 | 3 |
| 00-2255-033-32 | 3.2mm Drill                  | 3 |
| 00-2255-033-37 | 3.7mm Drill                  | 3 |
| 00-2255-033-50 | 5.0mm Drill                  | 3 |
| 00-2255-018-00 | Distal Screw Depth Gauge     | 1 |
| 00-2255-013-01 | Distal Screwdriver 3.5mm Hex | 1 |
| 00-2255-015-03 | Wand Handle                  | 1 |
| 00-2255-015-01 | Wand Insert                  | 1 |
| 00-2255-015-02 | Wand Set Screw               | 1 |

\* The 7mm Straight Awl (00-2237-001-07) OR the 7mm Angled Femoral Awl (00-2255-016-00) will fit in the case. However, when you order the set number (00-2255-000-16), you will get the Angled Awl.

NOTE: See sales representative for optional instruments.

**Pressure Sentinel Intramedullary Reaming System  
Order Information**

**Prod. No.**

**Description**

**00-2218-000-00 Long Pressure Sentinel Reamers  
Tray/Case/Lid**

Includes the following instruments & case:

|                |   |
|----------------|---|
| 00-2218-008-00 | 8.0mm Long Flexible PS Reamer                   |
| 00-2218-008-05 | 8.5mm Long Flexible PS Reamer                   |
| 00-2218-009-00 | 9.0mm Long Flexible PS Reamer                   |
| 00-2218-009-05 | 9.5mm Long Flexible PS Reamer                   |
| 00-2218-010-00 | 10.0mm Long Flexible PS Reamer                  |
| 00-2218-010-05 | 10.5mm Long Flexible PS Reamer                  |
| 00-2218-011-00 | 11.0mm Long Flexible PS Reamer                  |
| 00-2218-011-05 | 11.5mm Long Flexible PS Reamer                  |
| 00-2218-012-00 | 12.0mm Long Flexible PS Reamer                  |
| 00-2218-012-05 | 12.5mm Long Flexible PS Reamer                  |
| 00-2218-013-00 | 13.0mm Long Flexible PS Reamer                  |
| 00-2218-013-05 | 13.5mm Long Flexible PS Reamer                  |
| 00-2218-014-00 | 14.0mm Long Flexible PS Reamer                  |
| 00-2218-014-05 | 14.5mm Long Flexible PS Reamer                  |
| 00-2218-015-00 | 15.0mm Long Flexible PS Reamer                  |
| 00-2218-015-05 | 15.5mm Long Flexible PS Reamer                  |
| 00-2218-016-00 | 16.0mm Long Flexible PS Reamer                  |
| 00-2218-016-05 | 16.5mm Long Flexible PS Reamer                  |
| 00-2218-017-00 | 17.0mm Long Flexible PS Reamer                  |
| 00-2218-017-05 | 17.5mm Long Flexible PS Reamer                  |
| 00-2218-018-00 | 18.0mm Long Flexible PS Reamer                  |
| 00-2228-030-00 | T-Handle Extractor                              |
| 00-2228-097-00 | Diameter Gauge                                  |
| 00-5044-012-00 | Adapter 3 Jaw Chuck                             |
| 00-2228-098-10 | Soak Tray                                       |
| 00-2218-025-00 | Long Cleaning Brush                             |
| 00-2218-030-00 | Torque Limiter                                  |
| 00-2237-075-00 | Long Reamer/Instrument<br>Case Assembly         |
| 00-2237-076-00 | Long Reamer/Instrument Case Base                |
| 00-2237-077-00 | Long Reamer/Instrument Case Lid                 |
| 00-2237-078-00 | Long Reamer/Instrument Top Tray<br>(8mm-13.5mm) |
| 00-2237-079-00 | Long Reamer/Instrument Middle Tray              |

**00-2228-000-00 Pressure Sentinel Reamer Full Set**

Includes the following instruments & case:

|                |   |
|----------------|---|
| 00-2228-005-00 | 5.0mm Flexible Reamer                             |
| 00-2228-005-05 | 5.5mm Flexible Reamer                             |
| 00-2228-006-00 | 6.0mm Flexible Reamer                             |
| 00-2228-006-05 | 6.5mm Flexible Reamer                             |
| 00-2228-007-00 | 7.0mm Flexible Reamer                             |
| 00-2228-007-05 | 7.5mm Flexible Reamer                             |
| 00-2228-008-00 | 8.0mm Flexible Reamer                             |
| 00-2228-008-05 | 8.5mm Flexible Reamer                             |
| 00-2228-009-00 | 9.0mm Flexible Reamer                             |
| 00-2228-009-05 | 9.5mm Flexible Reamer                             |
| 00-2228-010-00 | 10.0mm Flexible Reamer                            |
| 00-2228-010-05 | 10.5mm Flexible Reamer                            |
| 00-2228-011-00 | 11.0mm Flexible Reamer                            |
| 00-2228-011-05 | 11.5mm Flexible Reamer                            |
| 00-2228-012-00 | 12.0mm Flexible Reamer                            |
| 00-2228-012-05 | 12.5mm Flexible Reamer                            |
| 00-2228-013-00 | 13.0mm Flexible Reamer                            |
| 00-2228-013-05 | 13.5mm Flexible Reamer                            |
| 00-2228-014-00 | 14.0mm Flexible Reamer                            |
| 00-2228-014-05 | 14.5mm Flexible Reamer                            |
| 00-2228-015-00 | 15.0mm Flexible Reamer                            |
| 00-2228-015-05 | 15.5mm Flexible Reamer                            |
| 00-2228-016-00 | 16.0mm Flexible Reamer                            |
| 00-2228-016-05 | 16.5mm Flexible Reamer                            |
| 00-2228-017-00 | 17.0mm Flexible Reamer                            |
| 00-2228-017-05 | 17.5mm Flexible Reamer                            |
| 00-2228-018-00 | 18.0mm Flexible Reamer                            |
| 00-2228-018-05 | 18.5mm Flexible Reamer                            |
| 00-2228-019-00 | 19.0mm Flexible Reamer                            |
| 00-2228-019-05 | 19.5mm Flexible Reamer                            |
| 00-2228-020-00 | 20.0mm Flexible Reamer                            |
| 00-2228-020-05 | 20.5mm Flexible Reamer                            |
| 00-2228-021-00 | 21.0mm Flexible Reamer                            |
| 00-2228-021-05 | 21.5mm Flexible Reamer                            |
| 00-2228-022-00 | 22.0mm Flexible Reamer                            |
| 00-2228-030-00 | T-Handle Extractor                                |
| 00-2228-097-00 | Diameter Gauge                                    |
| 00-2228-098-00 | Soak Tray   |
| 00-5044-012-00 | 1/4in. Jacob's Chuck to Zimmer<br>Adapter, Qty =2 |
| 00-2228-090-00 | Sterilization Case                                |

**Optional Reamer Sizes**

| Prod. No.      | Description            |
|----------------|------------------------|
| 00-2228-022-05 | 22.5mm Flexible Reamer |
| 00-2228-023-00 | 23.0mm Flexible Reamer |
| 00-2228-023-05 | 23.5mm Flexible Reamer |
| 00-2228-024-01 | 24.0mm Flexible Reamer |
| 00-2228-024-05 | 24.5mm Flexible Reamer |
| 00-2228-025-01 | 25.0mm Flexible Reamer |
| 00-2228-025-05 | 25.5mm Flexible Reamer |
| 00-2228-026-01 | 26.0mm Flexible Reamer |
| 00-2228-026-05 | 26.5mm Flexible Reamer |
| 00-2228-027-01 | 27.0mm Flexible Reamer |

**Pressure Sentinel Sets**

| Prod. No.             | Description   |
|-----------------------|---|
| <b>00-2228-000-01</b> | <b>Pressure Sentinel Reamer Trauma Set</b><br>Includes the following instruments & case:<br>5.0mm, 6.0mm, 7.0mm & 8.0mm-17.5mm Flexible Reamers in .5mm increments (1ea.) |
| 00-2228-030-00        | T-Handle Extractor  |
| 00-5044-012-00        | 1/4in. Jacob's Chuck to Zimmer Adapter, Qty=2   |
| 00-2228-090-00        | Sterilization Case  |
| <b>00-2228-000-02</b> | <b>Pressure Sentinel Reamer Hip Set</b><br>Includes the following instruments & case:<br>8.0mm-18.0mm Flexible reamers in 1mm increments (1ea.)                           |
| 00-2228-030-00        | T-Handle Extractor  |
| 00-5044-012-00        | 1/4in. Jacob's Chuck to Zimmer Adapter, Qty=1   |
| 00-2228-090-00        | Sterilization Case  |

|   |   |
|---|---|
| <b>00-2228-000-03</b>   | <b>Pressure Sentinel Reamer Expanded Hip Set</b><br>Includes the following instruments & case:<br>8.0mm-18.0mm Flexible reamers in .5mm increments (1ea.) |
| 00-2228-030-00  | T-Handle Extractor  |
| 00-5044-012-00  | 1/4in. Jacob's Chuck to Zimmer Adapter, Qty=1   |
| 00-2228-090-00  | Sterilization case  |
| <b>00-2228-90-00</b>  | <b>Sterilization Case</b><br>Includes the following components:   |
| 00-2228-091-00  | Base  |
| 00-2228-092-00  | 18.0mm to 22.0mm Reamer Tray  |
| 00-2228-093-00  | 12.0mm to 17.5mm Reamer Tray  |
| 00-2228-094-00  | 5.0mm to 11.5mm Reamer Tray   |
| 00-2228-096-00  | Case Lid  |
| <b>00-9975-011-00</b>   | <b>Pressure Sentinel Reamer ZMR® Hip Set</b><br>Includes the following components:<br>8.0mm-27.0mm Flexible reamers in .5mm increments (1ea.)             |
| 00-9965-081-10  | ZMR Flexible Reamer Diameter Gauge  |
| 00-9975-099-00  | Case Lid  |
| 00-2228-040-00  | ZMR Flexible Reamer Metal Case  |
| <i>* Set includes case and contents without the 00-9975-099-00 Case Lid. The Case Lid must be ordered separately.</i> |   |

**Optional Instruments**

| Prod. No.      | Description   |
|----------------|---|
| 00-2255-008-00 | Guide Wire 2.4mm, Ball-Tip, 70cm box (required for 5.0mm-7.5mm Pressure Sentinel Reamers)                   |
| 47-2255-008-01 | Guide Wire 3.0mm, Ball-Tip, 100cm Sterile/box (required for 8.0mm and larger Pressure Sentinel Reamers)     |
| 00-2255-008-01 | Guide Wire 3.0mm, Ball-Tip, 100cm Non-sterile/box (required for 8.0mm and larger Pressure Sentinel Reamers) |

**DISCLAIMER:**

This documentation is intended exclusively for physicians and is not intended for laypersons. Information on the products and procedures contained in this document is of a general nature and does not represent and does not constitute medical advice or recommendations. Because this information does not purport to constitute any diagnostic or therapeutic statement with regard to any individual medical case, each patient must be examined and advised individually, and this document does not replace the need for such examination and/or advise in whole or in part.

**Please refer to the package inserts for important product information, including, but not limited to, indications, contraindications, warnings, precautions, and adverse effects.**

Contact your Zimmer representative or visit us at [www.zimmer.com](http://www.zimmer.com)

The CE mark is valid only if it is also printed on the product label.

